



SPECIFICHE

Monocomando a bacinella
Inox T.E.A.+
Aeratore anticalcare M 24 x 1
Scarico 1 1/4" push
Flessibili inox ø 3/8"
Limitatore di portata con freno al 50%
Imballo: 56,5 x 29 x 7,1 cm / 0,011633 m³ / 3,003 kg

CERTIFICAZIONI





DIAGRAMMA DI PORTATA: ACQUA CALDA/FREDDA



DIAGRAMMA DI PORTATA: ACQUA MISCELATA

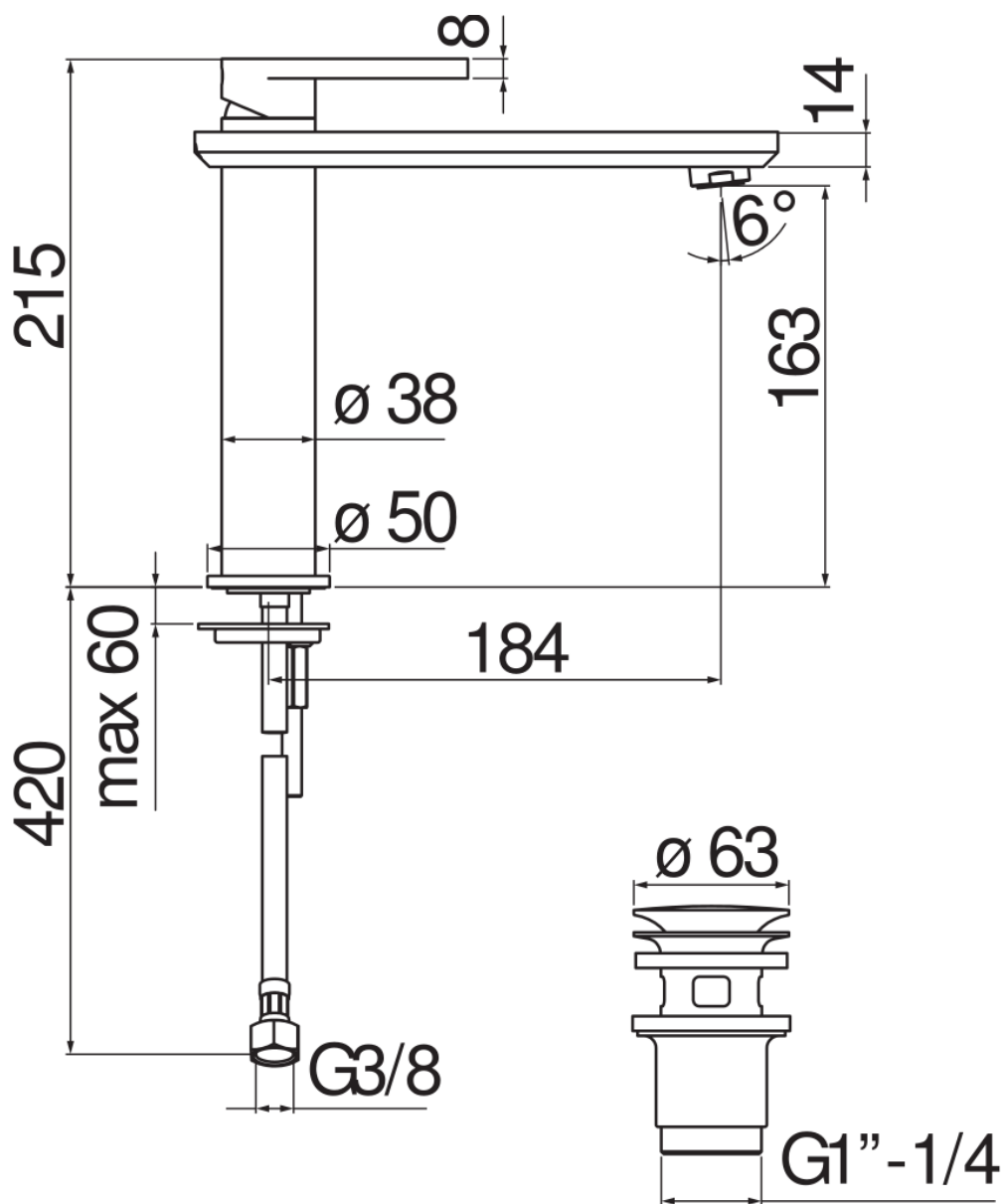
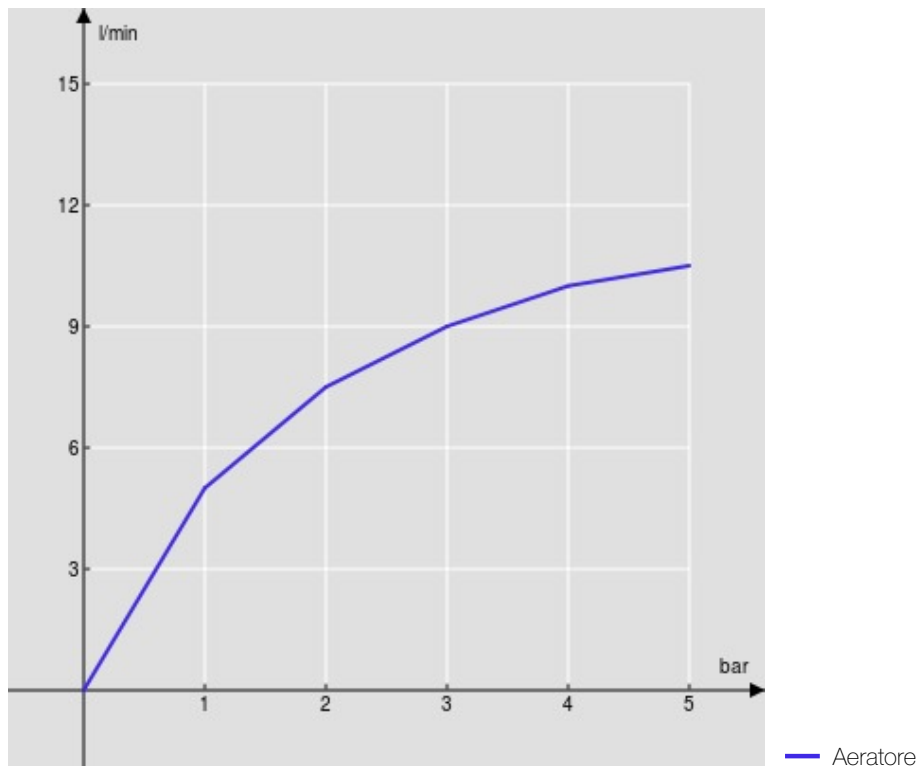